

Article number: 2310303641ESD

Description: E+G Antistatic base for levelling elements
LV.A-60-24-M16x138-ESD-C

Measures

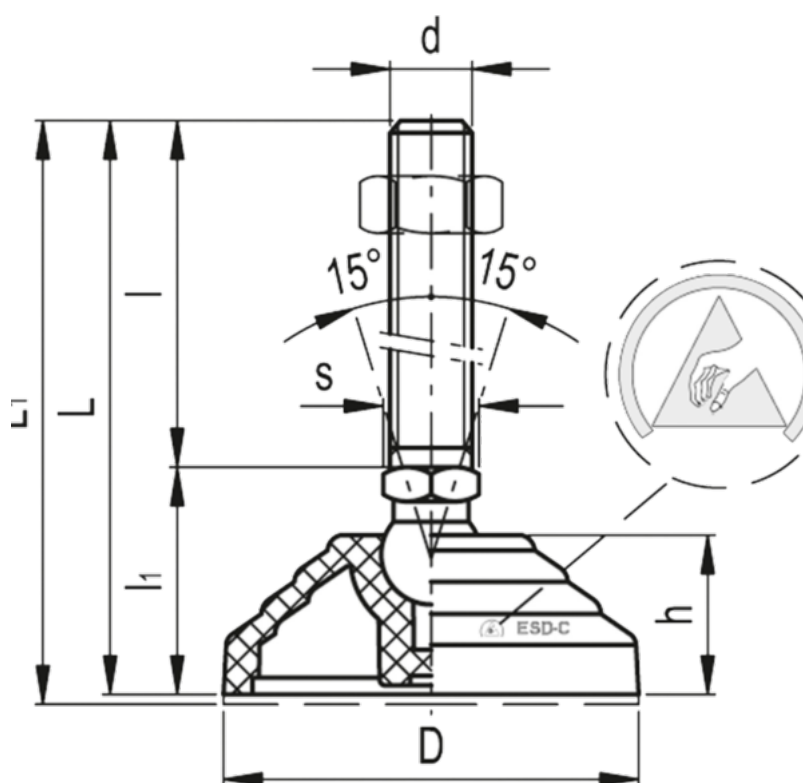

Articulation = 24
D = 60
d = M16
h = 24
l = -
l1 = -
L = 181
Max load = 18000

s = 24
Weight in (g) = 306